

Reliable isolation transformers from Tufvassons

Tufvassons have a wide range of transformers and over fifty years' experience of making them ourselves. We offer supreme quality isolation transformers for permanent installation, installation on DIN rails and movable variants that are connected by a mains lead. You can choose the product yourself, or ask our personnel to guide you to the right power supply.



Optimum isolation, removes interference

Isolation transformers are used when you need to adjust one voltage level to another, or separate protective earth from system earth. It offers optimum isolation, minimises interference and is easy to install and inspect. Just like Tufvassons' other products, the isolation transformer is CE marked and protected against short circuits and overloading.

Type:	PVM 900						
Part.no.:	6645-0028						
Input voltage:	230V, 50-60 Hz.						
Output voltage:	110V with centre tap.						
Rated power:	840VA (7,8A)						
Weight:	12.5 kg						
Encapsulation class:	IP54						
Insulation class:	4.2 kV						
Ambient temperature:	max 40°C						
Design:	<ul style="list-style-type: none"> - Transformer potted in hard-setting plastic, with grey encapsulation made from impact resistant, self extinguishing thermoplastics (V0). - Double insulated (earth connection not required). - Short circuit and overload protection with resettable 2x 10 A secondary overload circuit breaker. - Primary 2-pole terminal for up to 4 mm² cable, max torque 0.5 Nm. - Secondary 3-pole terminal for up to 4 mm² cable, max torque 0.5 Nm. - Secondary cable entry gland with 3 steps for cable max. dia. 18 mm. - Ducts for installation cable below the transformer. 						
Installation:	Wall installation, 3 screws, the upper 2 fixing holes are keyhole sockets.						
Manufacturing standard:	<table> <tr> <td>Security:</td> <td>EN 61558-1; EN 61558-2-4</td> </tr> <tr> <td>Emissions:</td> <td>EN 61 000-6-3; EN 61 000-6-4, IEC 62041</td> </tr> <tr> <td>Immunity:</td> <td>EN 61 000-6-1; EN 61 000-6-2, IEC 62041</td> </tr> </table>	Security:	EN 61558-1; EN 61558-2-4	Emissions:	EN 61 000-6-3; EN 61 000-6-4, IEC 62041	Immunity:	EN 61 000-6-1; EN 61 000-6-2, IEC 62041
Security:	EN 61558-1; EN 61558-2-4						
Emissions:	EN 61 000-6-3; EN 61 000-6-4, IEC 62041						
Immunity:	EN 61 000-6-1; EN 61 000-6-2, IEC 62041						
Other information:	If demanded by the installation regulations, the transformer must be connected by an all-pole switch in permanent installations.						



Wiring schedule and product illustration

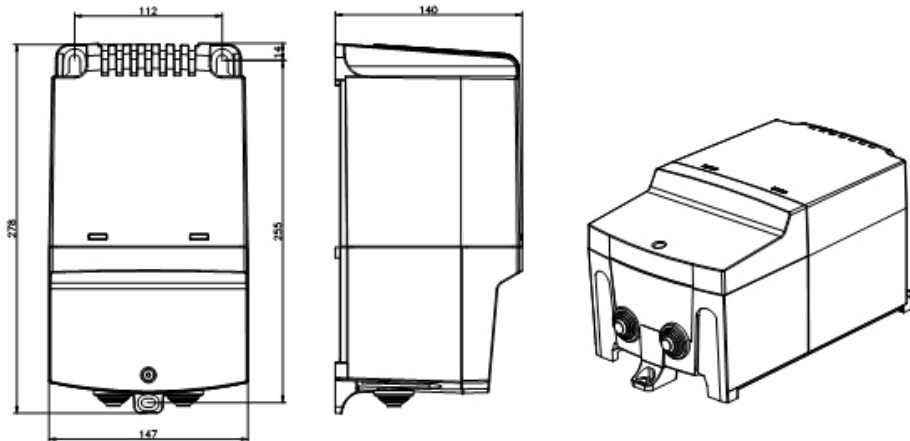
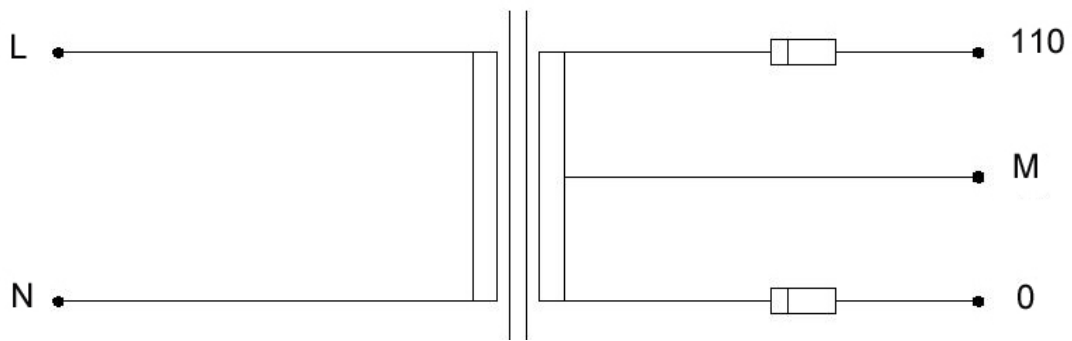

Loading diagram

